

KCM67T1/2-B1

---

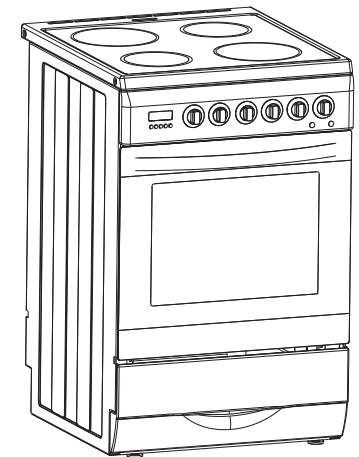

## INSTRUCTION MANUAL

---

Please read this instruction manual before using your new stove.

Cod:0040301178

## DEAR CUSTOMER

---

The cooker is exceptionally easy to use and extremely efficient. After reading the instruction manual, operating the cooker will be easy.

Before being packaged and leaving the manufacturer, the cooker was thoroughly checked with regard to safety and functionality.

Before using the appliance, please read the instruction manual carefully. By following these instructions carefully you will be able to avoid any problems in using the appliance.

It is important to keep the instruction manual and store it in a safe place so that it can be consulted at any time.

It is necessary to follow the instructions in the manual carefully in order to avoid possible accidents.

### **Caution!**

Do not use the cooker until you have read this instruction manual.  
The cooker is intended for household use only.  
The manufacturer reserves the right to introduce changes which do not affect the operation of the appliance.

## TABLE OF CONTENTS

---

Safety instructions.....	3
How to save energy.....	4
Unpacking.....	5
Disposal of the appliance.....	5
Description of the appliance.....	6
Installation.....	7
Operation.....	9
Before first use.....	9
Controlling the heating zones of the ceramic hob .....	9
Electronic programmer.....	10
Oven functions and operation.....	14
Cleaning and maintenance.....	18
Operation in case of emergency.....	18
Baking in the oven.....	19
Technical information.....	25
Electrical connection .....	26

## SAFETY INSTRUCTIONS

- The appliance becomes hot during operation. Take care not to touch the hot parts inside the oven.
- Always keep children away from the cooker. While in operation direct contact with the cooker may cause burns!
- Ensure that small items of household equipment, including connection leads, do not touch the hot oven or the hob as the insulation material of this equipment is usually not resistant to high temperatures.
- Do not leave the cooker unattended when frying. Oils and fats may catch fire due to overheating.
- Do not allow the cooktop to get soiled and prevent liquids from boiling over onto the surface of the cooktop, Any spillages should be cleaned up as they happen.
- Do not place pans with a wet bottom on the warmed up heating zones as this can cause irreversible changes to the cooktop(irremovable stains).
- Do not switch on the cooktop until a pan has been placed on it.
- Do not put pans weighing over 15kg on the opened door of the oven and pans over 25kg on the cooktop.
- Do not use harsh cleaning agents or sharp metal objects to clean the doors as they can scratch the surface, which could then result in the glass cracking.
- Do not use the cooker in the event of a technical fault. Any faults must be fixed by an appropriately qualified and authorized person.
- In the event of any incident caused by a technical fault, disconnect the power and report the fault to the service centre to be repaired.
- The rules and provisions contained in this instruction manual should be strictly observed. Do not allow anybody who is not familiar with the contents of this instruction manual to operate the cooker.
- The cooker should not be cleaned using steam equipment.
- **WARNING:** Accessible parts may become hot during use. Young children should be kept away.
- **WARNING:** In order to prevent accidental tipping of the appliance ,for example by a child climbing onto the open door, the stabilizing means must be installed.
- The oven must be switch off before removing the guard and that, after cleaning, the guard must be replaced in accordance with the instrctions.
- Ensure that the appliance is switch off before replacing the lamp to avoid the possibility of electric shock.
- **WARNING:** Accessible parts will become hot when the grill is in use .Children shoule be kept away.
- The appliance is not intended to be operated by means of an external timer or separate remote-control system.
- This appliance is not intended for use by persons (including children) with reduced physical, sensory or mental capabilities, or lack of experience and knowledge, unless they have been given supervision or instruction concerning use of the appliance by a person responsible for their safety.
- Children should be supervised to ensure that they do not play with the appliance.
- If the supply cord is damaged, it must be replaced by the manufacturer or its service agent or a similarly qualified person in order to avoid a hazard.
- Use pans that are specified by the manufactruer as designed for use with a ceramic hob.
- If the surface is cracked, switch off the appliance to avoid the possibility of electric shock.

Do not use pans with sharp edges that may cause damage to the ceramic hob. Do not look directly at the halogen heating zone (not covered with a pan) when they are warming up.

If the appliance used in New Zealand, this cooking range must be connected to the supply by a supply cord fitted with an appropriately rated plug that is compatible with the socket-outlet fitted to the final sub-circuit in the fixed wiring that is intended to supply this cooking range.

## HOW TO SAVE ENERGY



Using energy in a responsible way not only saves money but also helps the environment So let's save energy! And this is how you can do it:

- Use proper pans for cooking. Pans with thick, flat bases can save up to 1/3 on electric energy. Remember to cover pans if possible otherwise you will use four times as much energy.
- Match the size of the saucepan to the surface of the heating plates. A saucepan should never be smaller than a heating plate.
- Ensure heating plates and pan bases are clean. Soils can prevent heat transfer and repeatedly burnt-on spillages can often only be removed by products which cause damage to the environment.
- Do not uncover the pan too often (a watched pot never boils!). Do not open the cover door unnecessarily often.
- Switch off the oven in good time and make use of residual heat.

For long cooking times, switch off heating zones 5 to 10 minutes before finishing cooking. This saves up to 20% on energy.

- Only use the oven when cooking larger dishes. Meat of up to 1 kg can be prepared more economically in a pan on the cooker burner.
- Make use of residual heat from the oven. If the cooking time is greater than 40 minutes it is recommended to switch off the oven 10 minutes before the end time.

### **Caution!**

When using the timer set appropriately shorter cooking times according to the dish being prepared.

- Only grill with the ultrafan after closing the oven door.
- Make sure the oven door is properly closed. Heat can leak through spillages on the door seals. Clean up any spillages immediately.
- Do not install the cooker in the direct vicinity of refrigerators/freezers. Otherwise energy consumption increases unnecessarily.

## UNPACKING



During transportation, protective packaging was used to protect the appliance against any damage.

After unpacking, please dispose of all elements of packaging in a way that will not cause damage to the environment. All materials used for packaging the appliance are environmentally friendly; they are 100% recyclable and are marked with the appropriate symbol.

### **Caution!**

During unpacking, the packaging materials (polythene bags, polystyrene pieces, etc.) should be kept out of reach of children.

## DISPOSAL OF THE APPLIANCE



Old appliances should not simply be disposed of with normal household waste, but should be delivered to a collection and recycling centre for electric and electronic equipment.

A symbol shown on the product, the instruction manual or the packaging shows that it is suitable for recycling.

Materials used inside the appliance are recyclable and are labelled with information concerning this. By recycling materials or other parts from used devices you are making a significant contribution to the protection of our environment.

Information on appropriate disposal centres for used devices can be provided by your local authority.

## DESCRIPTION OF THE APPLIANCE

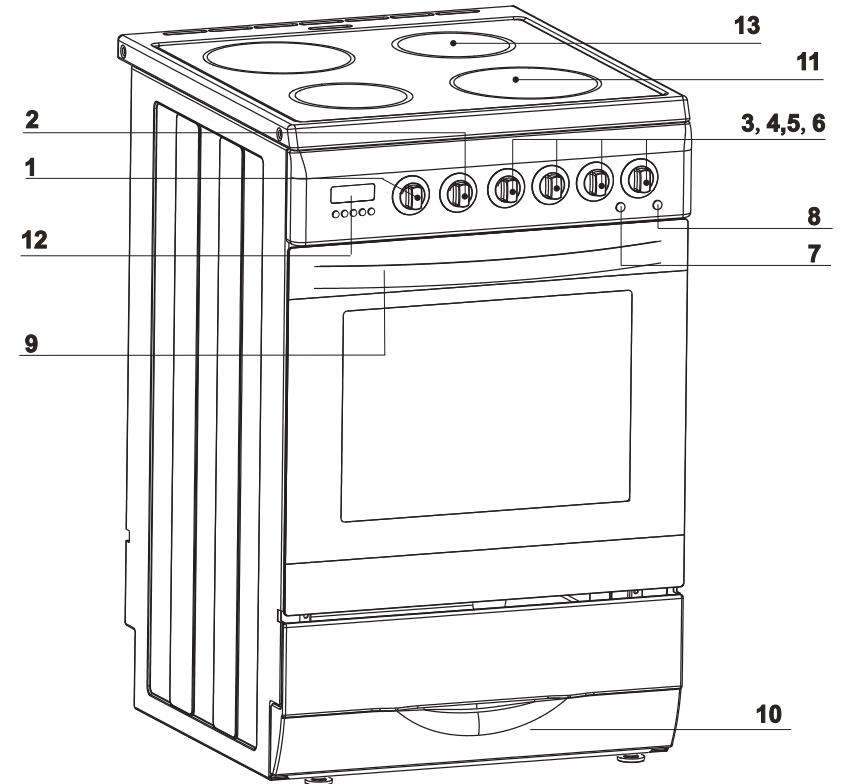

- 1 Temperature control knob
- 2 Oven function selection knob
- 3,4,5,6 Heating plate control knobs
- 7 Cooker operation signal light yellow
- 8 Oven temperature control signal light red
- 9 Oven door handle
- 10 Drawer
- 11 180mm Hi-light heater
- 12 Electronic programmer
- 13 145mm Hi-light heater

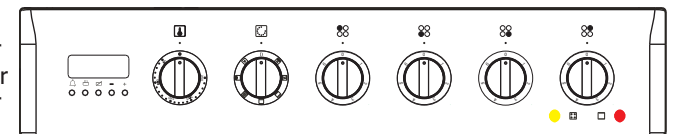

## INSTALLATION

---

### Installing the cooker

- The kitchen should be dry and airy and have effective ventilation according to the existing technical provisions.
- The room should be equipped with a ventilation system that pipes away exhaust fumes created during combustion. This system should consist of a ventilation grid or hood. Hoods should be installed according to the manufacturer's instructions. The cooker should be placed so as to ensure free access to control elements.
- Coating or veneer used on fitted furniture must be applied with a heat resistant adhesive (100°C). This prevents surface deformation or detachment of the coating. If you are unsure of your furniture's heat resistance, you should leave approximately 2 cm of free space around the cooker. The wall behind the cooker should be resistant to high temperatures. During operation, its back side can warm up to around 50°C above the ambient temperature.

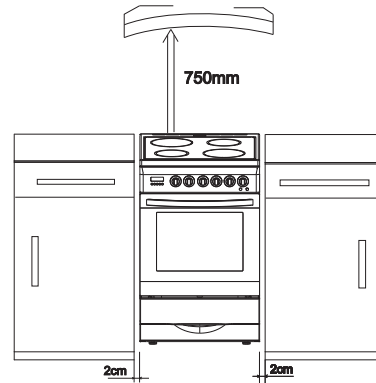

- The cooker should stand on a hard, even floor (do not put it on a base.)

## INSTALLATION

---

- Before you start using the cooker it should be leveled, which is particularly important for fat distribution in a frying pan. To this purpose, adjustable feet are accessible after removal of the drawer. The adjustment range is +/-5mm.

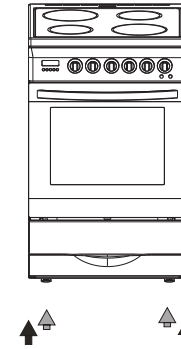

# OPERATION

## Before first use

- Remove packaging and empty the drawer. Clean the interior of the oven with warm soapy water and wipe clean with moistened cloth or sponge. Wipe clean the cooktop.
- Take out and wash the oven fittings with warm water and a little washing-up liquid.
- Switch on the ventilation in the room or open a window.
- Heat the oven (to a temperature of 250, for approx. 30 min.), remove any stains and wash carefully. The hotplates should be heated for around 4 minutes without a pan or pot on them.
- When heating the oven for the first time it is normal for the stove to give off smoke and manufacturing odours. These will disappear after about 30 Minutes.

## Controlling the heating zones of the ceramic hob

### Choice of cookware

Choose a pan with a diameter that is at least as large as the heating zone. Do not use pans with a concave and convex base. Always remember to put a proper cover on the pan. We recommend the use of pans with thick, even bases.

If the heating zones and pans are solid it is impossible to make full use of the heat.



### Heat level selection

The heating zones have different levels of heat. The level of heat can be adjusted gradually by turning the appropriate knob to the right or left. The knobs are unfolded on the control panel, to select it you should:

- push the knob gently and then turn it;
- set it to the right position.

The marks at the knob show the different levels reached by the heating zones.

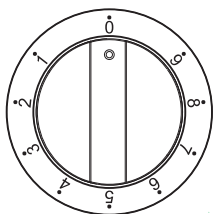

Step	Suitable for
0	hot plate off, use of remaining heat
1-2	maintaining temperature, slow cooking, small quantities of food (min power)
3	slow cooking
4-5	slow cooking of large quantities, slow frying of large big chunks
6	frying, preparing soup basis
7-8	fry
9	boiling, browning, frying (maximum power)

# OPERATION

## Zone heating indicator

If the temperature of a heating zone exceeds 65 degrees this is signalled by an indicator which lights up for that zone.

When the heating indicator lights up it warns the person using the cooker against touching a hot heating zone.

For about 5 to 10 minutes after a heating zone is switched off it will still have residual heat that can be used, for example to warm up or keep dishes warm without switching on another heating zone.

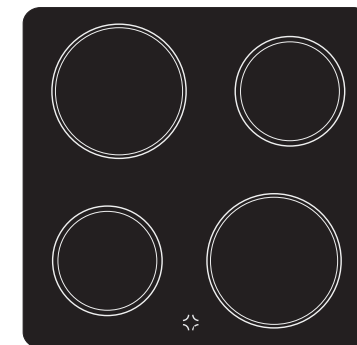

Zone heating indicator

## ▶ Electronic programmer

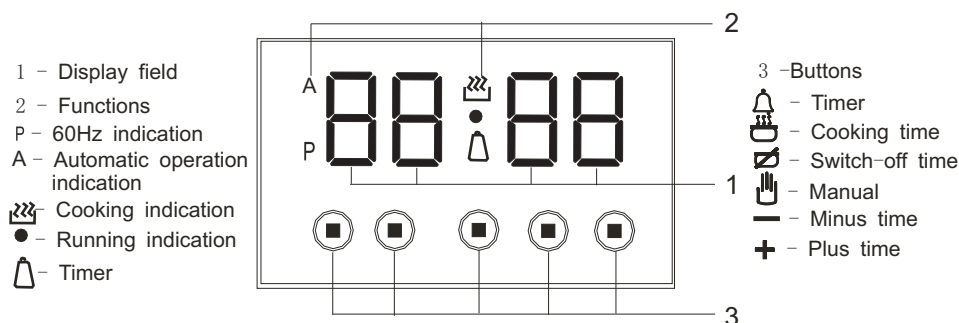

### Caution!

Before any setting, press buttons 2 and 3 simultaneously to start the oven.

### Setting the time

1. After connection to the mains or reconnection after a power cut, the display, shows flash "0.00" and "A".

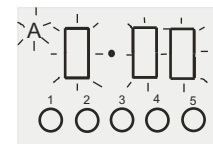

2. Press buttons 2 and 3 simultaneously, the signal function [Cooking icon] is on.

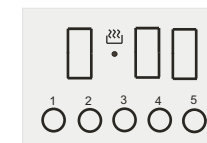

3. The signal function [Cooking icon] is flashing, set the current time using buttons 4 and 5. 5 seconds after the time has been set, the new data will be saved. The signal function [Cooking icon] is on.

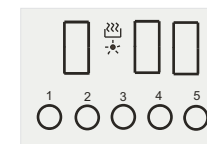

## OPERATION

### Timer

The timer can be activated at any time and any function. The timer can be set for from 1 minute to up to 23 hours and 59 minutes.

To set the timer you should:

1. Press button 1, the display will show "0.00" and flashing .

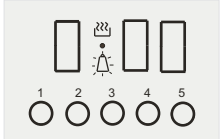

2. Set the timer using buttons 4 and 5.

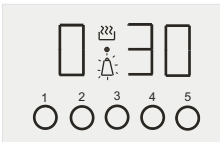

3. 5 seconds after the time is set, the signal function  is on. The new data will be saved and the display will show the current time.

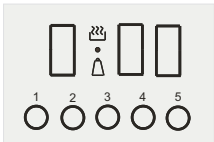

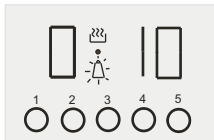

4. Press button 1, the remanent time will be shown on the display. ( In the last minute, the display will show the remanent seconds )

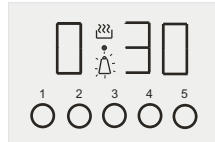

If you want to reset the timer, repeat step 2.

5. When the set time is up the alarm signal will be activated and the signal function  starts flashing again.



6. Press any button, the signal function  will go off. If the alarm signal is not turned off manually, it will be turned off automatically after 7 minutes.

### Caution!

Besides timer alarm, any other alarms can be turned off by pressing button 1, 2 or 3. If the alarm signal is not turned off manually, it will be turned off automatically after 7 minutes.

There are three different alarm sounds for your choice. When the display field shows the current time, press button 4, you can select the alarm sound you want. Once the alarm sound is set, it will be introduced to the memory.

### Semi-automatic operation

If the oven is to be switched off at a given time, or after defined period, you should:

1. Set the oven function knob and the temperature regulator knob to the setting at which you want the oven to operate.
2. Press buttons 2 and 3 simultaneously, the oven will begin to work and the function signal  is on.
3. Press button 2 or 3, then the display will show flashing "A".
4. Set the required time using buttons 4 and 5, within a range from 1 minute to 10 hours.
5. The set time is introduced to the memory after 5 seconds, then the display will show the current time. At the same time, the function signal "A" is on.
6. When the set time has passed, the oven is switched off automatically, the alarm is activated, the signal function

## OPERATION

 is off, and the signal function "A" starts flashing again.

7. Press button 1, 2 or 3, the signal "A" will go off. Or if the alarm signal is not turned off manually, it will be turned off automatically after 7 minutes.

### Caution!

- The cooking time and switch-off time range  
Cooking time range:  $0 < t \leq 10$  hours  
Switch-off time range: current time < switch-off time  $\leq$  current time + 10 hours  
Switch-off time = current time + cooking time
- Set the cooking time or switch-off time  
When use the semi-automatic operation, set either the cooking time or the switch-off time.
- If set the cooking time to be 0 or set the switch-off time to be the current time, the auto function will be off.

### For example:

The current time is 2:00, the maximum switch-off time is set to be 12:00 (2:00+10:00=12:00).

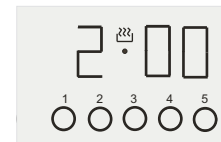

There are two methods to achieve this setting:

First method:

1. Press button 2, then the display will show flashing "A".

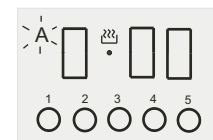

Set the cooking time using buttons 4 and 5.

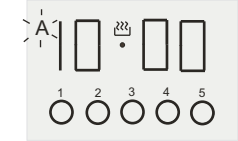

Press button 3, then the display will show flashing "A".

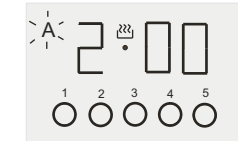

Set the switch-off time using buttons 4 and 5.

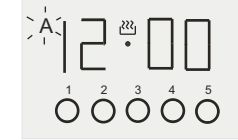



seconds after the setting, the auto current time shows "0.00" The alarm signal is activated, the  is off, and the signal "A" starts flashing.

### Automatic operation

If the oven is to be switched on for a specified period of time and switched off at a fixed hour then you should set the cook time and the stop time:

1. Set the oven function knob and the temperature regulator knob to the setting at which you want the oven to operate.
2. Press buttons 2 and 3 simultaneously, the oven will begin to work and the function signal  is on.
3. Press button 2, then the display will show flashing "A". Set the cooking time using buttons 4 and 5, within a range from 1 minute to 10 hours
4. Press button 3, set the switch-off time using buttons 4 and 5.

## OPERATION

- The set time is introduced to the memory after 5 seconds, then the function signal "A" is on. When the work time is reached, the oven will begin to work and the display will show the current time. At the same time, the function signal  is on.
- When the set time has passed, the oven is switched off automatically, the alarm signal is activated, the signal function  is off, and the signal function "A" starts flashing again.
- Press button 1, 2 or 3, the signal light will go off. Or if the alarm signal is not turned off manually, it will be turned off automatically after 7 minutes.

### Caution!

- work time = switch-off time - cooking time

### For example:

If the current time is 2:00; cooking time set to be 3 hours; switch-off time set to be 10:00, the work time will be 7:00 (7:00=10:00-3:00).

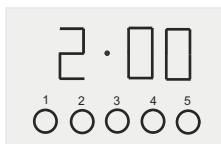

- Press button 2 and 3 simultaneously, the oven begins to work, and the signal function  is on.

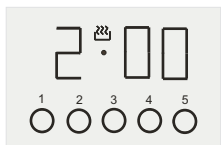

- Press button 2, then the display will show flashing "A".

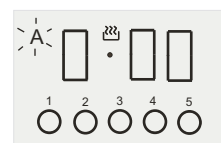

- Set the cooking time to be "3.00" with buttons 5.

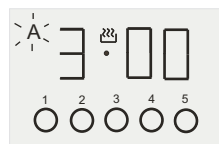

- Press button 3.

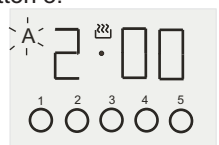

- Set the switch-off time to be "10.00" with buttons 5, the signal function  goes out.

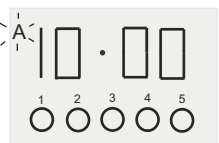

- 5 seconds after setting, the auto function "A" is on.

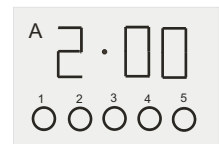

- When it is up to 7:00, the oven will begin to work and the signal function  is on.

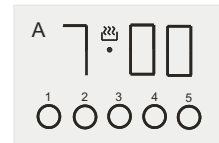

- When it is up to 10:00, the alarm signal is activated, the signal function  is off, and the signal "A" starts flashing.

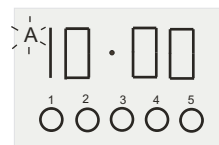

## OPERATION

- If the lasting time set to be 0 or the switch-off time set to be the current time, the auto function will be off.

### Cancel settings

#### Cancel any function

Turn the oven function selection knob to "0". 10 seconds later, run the oven again.

#### Cancel automatic function

Press button 2 and 3 simultaneously, the auto function will be canceled, and the function signal 'A' will go out. Then the display will show the current time.

#### Cancel timer settings

Press button 1 to select timer settings, and then press button 4 and 5 simultaneously.

### Oven functions and operation

Oven is controlled by the function knob and mechanical timer and the temperature selection knob.

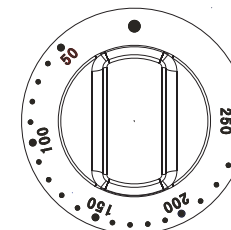

Temperature selection knob

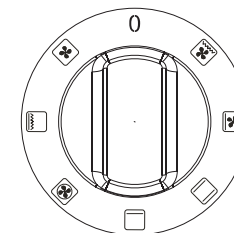

The function knob

### Caution!

When selecting any heating function (switching a heater on etc.) the oven will only be switched on after the temperature has been set by the temperature regulator knob.

### Possible settings of the oven function knob



Bottom heater

At this oven function knob position, the oven activates the bottom heater.



Fan, bottom and top heaters on

At this knob position the oven executes the cake function. Conventional oven with a fan.

## OPERATION



### Fan grill heaters

When the knob is turned to this position, the oven activates the grill and fan function. In practice, this function allows the grilling process to be speeded and an improvement in the taste of the dish, you should only use the grill with the oven door shut.



### Bottom and top heaters on

Setting the knob to this position allows the oven to be heated conventionally.



### Grill and the top heater

When the “combined grill” is active it enables grilling with the grill and with the top heater switched on at the same time.

This function allows a higher temperature at the top of the cooking area, which causes more intense browning of the dish and permits larger portions to be grilled.

### Use of the grill

The grilling process operates through infrared rays emitted onto the dish by the incandescent grill heater.

In order to switch on the grill you need to:

- Set the oven knob to the position marked grill.
- Heat the oven for approx. 5 minutes (with the oven door shut).
- Insert a tray with a dish onto the appropriate cooking level; and if you are grilling on the grate insert a tray for dripping on the level immediately below (under the grate).
- Close the oven door.

For grilling with the function grill and combined grill the temperature must be set to 250 °C, but for the function fan and grill it must be set to a maximum of 200 °C.

### **Warning!**

When using function grill it is recommended that the oven door is closed.

When the grill is in use accessible parts can become hot.

It is best to keep children away from the oven.



### Fan only

This function for defrosting



### Circular heater fan

At this function, allows the oven to be heating up in a forced way with the thermofan, which is in the central part of the oven heating method is:

Reduction of oven heating-up time and of the initial heating stage.

Possibility to bake at two cooking levels simultaneously.

### **Caution!**

When the functions with fan have been selected but the temperature knob is set to zero only the fan will be on.

With this function you can cool the dish or the oven chamber.

## OPERATION

### Oven guide levels

Baking pans and accessories (oven grid, baking tray, etc) may be inserted into the oven in 5 guiding levels.

Appropriate levels are indicated in the tables that follow.

Always count levels from the bottom upwards!

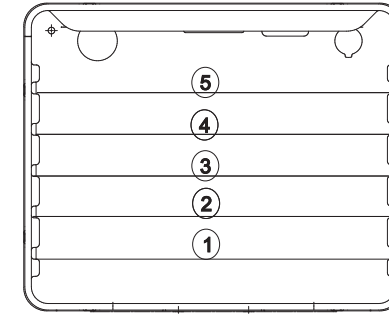

### Fitting Oven Shelves

1. Ensure shelf orientation is correct (refer picture below)

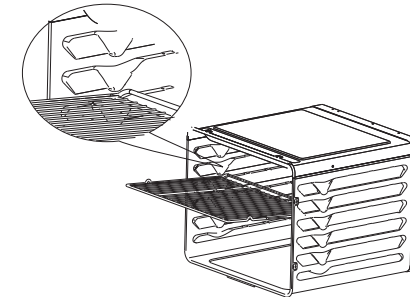

2. Slide into oven at an angle until raised back of shelf is past the stop on side runners.
3. Lower front of shelf and push in until stop is reached.
4. To remove oven shelves, withdraw to the stop and raise the front of shelf to clear the stop.

## CLEANING AND MAINTENANCE

By ensuring proper cleaning and maintenance of your oven you can have a significant influence on the continuing fault-free operation of your appliance.

Before you start cleaning, the oven must be switched off and you should ensure that all knobs are set to the “0” position. Do not start cleaning until the oven has completely cooled.



- The oven should be cleaned after each use.
- Cool the oven completely before cleaning.
- Never clean the appliance with pressurised hot steam cleaner!

## CLEANING AND MAINTENANCE

- The oven chamber should only be washed with warm water and a small amount of washing-up liquid.

### ● Steam cleaning

-pour 250ml of water (1 cup) into a bowl placed in the oven on the first level from the bottom.

-Close the oven door,

-Set the temperature knob to 50 °C, and the function knob to the bottom heater position,

-heat the oven chamber for approximately 30 minutes,

-Open the oven door, wipe the chamber inside with a cloth or sponge and wash using warm water with washing-up liquid.

- After cleaning the oven chamber wipe it dry.

### **Caution!**

Do not use cleaning products containing abrasive materials for the cleaning and maintenance of the glass front panel.

- When cleaning do not use cleaning agents with a strong abrasive effect, such as e.g. scouring powders containing an abrasive, abrasive compounds, abrasive stones, pumice stones, wire brushes and so on. They may scratch the hob surface, causing irreversible damage.
- Large spillages that are firmly stuck to the hob can be removed by a special scraper; but be careful not to damage the ceramic hob frame when doing this.

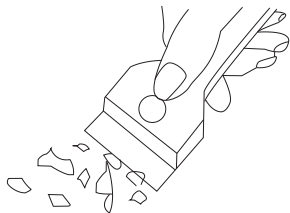

Scraper for cleaning the hob

### **Caution!**

The sharp blade should always be protected by adjusting the cover (just push it with your thumb). Injuries are possible so be careful when using this instrument-keep out of reach of children.

- Appropriate light cleaning or washing products are recommended, such as e.g. any kind of liquids emulsions for fat removal. Alternatively a solution of warm water with a little washing-up liquid or cleaning products for stainless steel sinks can be used.

### ▷ Replacement of the oven light bulb

In order to avoid the possibility of an electric shock ensure that the appliance is switched off before replacing the bulb.

- Set all control knob to the position "0" and disconnect all power supply.
- Unscrew and wash the lamp cover and then wipe it dry.
- Unscrew the light bulb from the socket, replace the bulb with a new one-a high temperature bulb (300°C) with the following parameters: **Oven light bulb**
  - Voltage 220-240V
  - Power 25 W
  - thread E 14.
- Screw the bulb in, making sure it is properly inserted into the ceramic socket.
- Screw in the lamp cover.

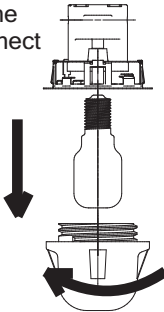

## CLEANING AND MAINTENANCE

### ▷ Door removal

In order to obtain easier access to the oven chamber for cleaning, it is possible to remove the door.

To do this, tilt the safety catch part of the hinge upwards. Close the door lightly, lift and pull it out towards you. In order to fit the door back on to the cooker, do the reverse. When fitting, ensure that the notch of the hinge is correctly placed on the protrusion of the hinge holder. After the door is fitted to the oven, the safety catch should be carefully lowered down again. If the safety catch is not set it may cause damage to the hinge when closing the door.

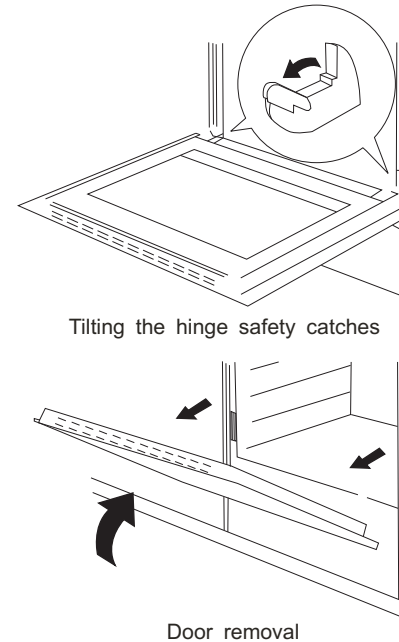

## OPERATION IN CASE OF EMERGENCY

In the event of an emergency, you should:

- switch off all working units of the oven

### ▷ Removal of the internal glass panel

Unscrew and unfasten the plastic latch that is in the corner at the top of the door. Next take out the glass from the second blocking mechanism and remove. After cleaning, set and block the glass panel, and screw in the blocking mechanism.

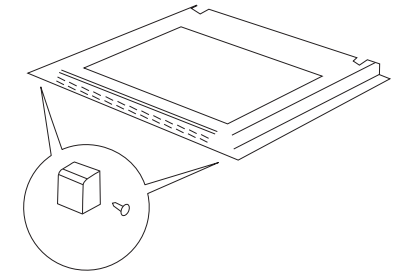

Removal of the internal glass panel

### ▷ Regular inspections

Besides keeping the cooker clean, you should:

- Carry out periodic inspections of the control elements and cooking units of the cooker. After the guarantee has expired you should have a technical inspection of the cooker carried out at a service centre at least once every two years.
- Fix any operational faults.
- Carry out periodical maintenance of the cooking units of the cooker.

### **Caution!**

All repairs and regulatory activities should be carried out by the appropriate service centre or by an appropriately authorized fitter.

## BAKING IN THE OVEN

- disconnect the mains plug
- call the service centre
- some minor faults can be fixed by referring to the instructions given in the table below. Before calling the customer support centre or the service centre check the following points that are presented in the table.

PROBLEM	REASON	ACTION
1. The appliance does not work.	Break in power supply.	Check the household fuse box; if there is a blown fuse replace it with a new one.
2. The programmer display is flashing "0.00".	The appliance was disconnected from the mains or there was a temporary power cut.	Set the current time (see Use of the programmer).
3. The oven lighting does not work.	The bulb is loose or damaged.	Tighten up or replace the blown bulb(see Cleaning and Maintenance)

### Baking cakes and loaves

#### Warning!

- The baking parameters given in Tables are approximate and can be corrected based on your own experience and cooking preferences.
- In case you may not find any particular type of cake in the tables, use the information available for the next most similar type of cake.

#### Baking with upper and lower heaters

- Use only a single guide level.
- This baking position is especially suitable for baking dry pastry, bread and teacakes. Use dark baking pans. Light pans reflect heat and pastry is not adequately browned.
- Always place baking pans on the grid rack. Remove the grid only of baking in the flat biscuit tray, supplied with the appliance.
- Preheating shortens the baking time. Do not put the cake in the oven until proper temperature is obtained. gradually by turning the appropriate knob to the right or left. The knob is unfold on

#### Baking tips

##### Is cake cooked?

Pierce the cake with a wooden peg at the thickest part, if the dough does not stick to it, the cake is baked. You may switch off the oven and use the remaining heat.

##### cake has fallen

Check the recipe. Use less fluid next time. Follow the mixing times, especially when using powered kitchen mixers.

##### cake is too light on the bottom

Use dark baking pan next time, or place the pan one level lower, or switch on the lower heater a while before the completion.

##### Cheese cake is undercooked

Next time reduce the baking temperature and extend the baking time.

#### Warnings regarding the baking tables

- The tables indicate the temperature range. Always select lower temperature first. You may always increase the temperature in case pastry needs more baking.
- Baking times are indicative only. They may vary in dependence of individual characteristics.
- The asterisk indicates that the oven requires preheating.

## BAKING IN THE OVEN

### Baking Table is for cakes and loaves

Type of cake	Guide level (from down upwards)	Temp (°C)	Baking time (in min.)
<b>Sweet cake</b>			
Raisin cake	2	150-160	55-70
Ring cake	2	150-160	60-70
Tree cake (tart form)	2	150-160	45-60
Cheese cake (tart form)	2	160-170	60-80
Fruit cake	2	170-180	50-70
Fruit cake with icing	2	160-170	60-70
Sponge cake	2	160-170	30-40
Flake cake	3	170-180	25-35
Fruit cake mix dough	3	160-170	50-70
Cherry cake	3	170-200	30-50
Jelly roll	3	170-180	15-25
Fruit fan	3	150-160	25-35
Plait bun	2	180-210	35-50
Christmas cake	2	170-200	45-70
Apple pie	2	170-200	40-60
Puff paste	2	160-170	40-60
<b>Salted pastry</b>			
Bacon roll	2	170-180	45-60
Pizza	2	210-230	30-45
Bread	2	180-210	50-60
Rolls	2	200-220	30-40
<b>Biscuits and pastries</b>			
Caraway roll	3	160-170	15-25
Biscuits	3	160-170	20-30
Danish pastry	3	170-200	20-35
Flaky pastry	3	180-200	20-30
Cream puff	3	170-200	25-45
<b>Frozen foods</b>			
Apple pie, cheese pie	2	170-200	50-70
Cheese cake	2	170-180	65-85
Pizza	2	200-220	20-30
Chips for oven	2	200-220	20-35
Potato fries for	2	200-220	20-35

## BAKING IN THE OVEN

### ▷ Roasting

Best heating mode for each type of roasting pan is indicated by bold print in the Roasting Tables.

#### Tips regarding roasting pans

- Use light enamel pans, temperature resistant glass pans, clay dishes or wrought iron dishes.
- Stainless steel dishes are not recommendable because they excessively reflect heat.
- Cover your roast or wrap it in foil. It will preserve its juice and the oven will remain cleaner.
- If you leave the pan uncovered the roast will be cooked sooner. Roast large chunks of meat directly on the grid, with intercepting pan underneath.

#### Attention when roasting!

Roasting tables indicate suggested temperatures, guide guide and roasting times. Roast time largely depends upon the type of meat, its size and quality. So you may expect some variations.

- Roasting of large chunks of meat may produce excessive steaming and dew formation at the oven door. This is quite normal, and does not affect the operation of the oven. However, after the completion of roasting wipe the oven door and the glass thoroughly.
- Roasting of red meat, poultry and fish is rational if the roast exceeds one kilogram in size.
- Add as much liquid as necessary to prevent burning of juice, dripping from meat. Roast must be surveyed at all times. And liquid added if necessary.
- At approximately the middle of the indicated time turn the roast round, especially if you use the deep roast dish.
- When roasting on the grill grid, place the grid in the deep roasting pan and insert both into the sliding guide. The bottom pan will intercept dripping fat.
- Never leave roast to cool in the oven, as it might produce dew and corrosion of the oven.

## BAKING IN THE OVEN

### Roasting table

Type of meat	Weight (in grams)	Shelf position (from down upwards)	temp (°C) 	Roasting time (in min.)
<b>Beef</b>				
Beef loin	1000	2	200-220	100-120
Beef loin	1500	2	200-220	120-150
Roast beef, rare	1000	2	220-230	30-40
Roast beef, well done	1000	2	220-230	40-50
<b>Pork</b>				
Pork roast with skin	1500	2	170-180	140-160
Flank	1500	2	180-190	120-150
Flank	2000	2	170-200	150-180
Pork loin	1500	2	200-220	120-140
Meat roll	1500	2	200-220	120-140
Pork cutlet	1500	2	170-200	100-120
Minced meat roast	1500	2	210-220	60-70
<b>Veal</b>				
Veal roll	1500	2	170-200	90-120
Veal knuckle	1700	2	170-200	120-130
<b>Lamb</b>				
Lamb prime ribs	1500	2	180-200	100-120
Mutton blade bone	1500	2	180-200	120-130
Ham	1500	2	180-210	100-120
<b>Poultry</b>				
Chicken entire	1200	2	200-210	60-70
Hen	1500	2	200-210	70-90
Duck	1700	2	170-200	120-150
Goose	4000	2	150-160	180-200
Turkey	5000	2	140-150	180-240
<b>Fish</b>				
Fish, entire	1000	2	200-210	50-60
Fish soufflé	1500	2	170-200	50-70

## BAKING IN THE OVEN

### BAKING IN THE OVEN

#### ▷ Grilling

- Take extra precautions when grilling. Intensive heat from infrared heater makes the oven and the accessories extremely hot. Use protective gloves and barbecue accessories!
- Perforated roast may produce spurting of hot grease (sausages). Use long grill tongs to prevent skin burns and protect your eyes.
- Supervise the grill at all time. Excessive heat may quickly burn your food and provoke fire!
- Do not let the children in the vicinity of the grill.

Grill heater is especially suitable for the preparation of low-fat sausages, meat and fish fillets and steaks, and for browning and crisping the roast skin.

#### Tips for grilling

- Grilling should be carried out with the oven door closed.
- Grilling tables indicate the recommended temperature, guide levels and grilling times, which may vary according to the weight and quality of meat.
- Grill heater should be pre-heated for 3 minutes.
- Oil the grill grid before placing the food, otherwise food might stick to the grid.
- Place the meat upon the grid, then place the grid upon the grease interception pan. Insert both trays into the oven guides.
- Turn the meat round after half of the roasting time has expired. Thinner slices will require only one turn, for larger chunks you might need to repeat the procedure. Always use barbecue tongs to avoid losing excessive juice from meat.
- Dark beef meat is grilled quicker than lighter pork or veal.
- Clean the grill, the oven and the accessories each time after use.

## BAKING IN THE OVEN

#### Grill table

Type of meat for grill	Weight (in grams)	Shelf position (from bottom up)	Temp (°C) 	Grill time (in min.)
<b>Meat and sausages</b>				
2 beefsteaks, rare	400	5	240	14-16
2 beefsteaks, medium	400	5	240	16-20
2 beefsteaks, well done	400	5	240	20-23
2 pork scrag fillets	350	5	240	19-23
2 pork chops	400	5	240	20-23
2 veal steaks	700	5	240	19-22
4 lamb cutlets	700	5	240	15-18
4 grill sausages	400	5	240	9-14
2 slices of meat cheese	400	5	240	9-13
1 chicken, halved	1400	3	240-250	28-33(1.side) 23-28(2.side.)
<b>Fish</b>				
Salmon fillets	400	4	240	19-22
Fish in aluminium foil	500	4	230	10-13
<b>Toast</b>				
4 slices of white bread	200	5	240	1,5-3
2 slices of whole meal	200	5	240	2-3
Toast sandwich	600	5	240	4-7
<b>Meat/poultry</b>				
Chicken	1000	3	180-200	60-70
Pork roast	1500	3	160-180	90-120
Pork scrag	1500	3	160-180	100-180
Pork knuckle	1000	3	160-180	120-160
Roast beef/ beef fillet	1500	3	190-200	40-80

## TECHNICAL INFORMATION

TYPE	KCM67T1/2-B1
Dimensions (height/width/depth) cm	90/60/60
<b>Cooktop</b>	
180mm Hilight heater(kW)	1.8
145mm Hilight heater(kW)	1.2
<b>Oven</b>	
Temperature regulator / function mode switch	1/1
Guide levels (telescopic guides in 3levels-only certain models)	5
Top/bottom heater(kW)	0,85/1,15
Grill heater(kW)	1.1
Oven illumination(W)	25
<b>Function modes</b>	
Top/bottom heater(kW)	2,0
bottom heater(kW)	1.15
Top/bottom heater/fan (kW)	2,0
Separate oven lighting (W)	25
Bottom heater/fan(KW)	1,2
Top/grill (kW)	1.95
Grill heater(kW)	1.1
Max. temperature	250°C
Electric connection	400V 3N-,50Hz
Nominal voltage of heaters	220-240V
Total connected power(kW)	8.0
Oven total(kW)	2,0
Hotplate total(kW)	6
Weight(kg)	45
Energy rating	On the energy label

Complies with AS/NZS regulations EN 50304, AS/NZS60335-1,AS/NZS60335-2-6 standards.







## ELECTRICAL CONNECTION

### Caution!

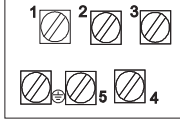
All electrical work should be carried out by a suitably qualified and authorized electrician. No alterations or willful changes in the electricity supply should be carried out. The fixing line connected must be equipped with the all-pole disconnection device provided by breakaway the contact under overvoltage category III according to the the wiring rules.

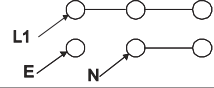
### Fitting guidelines

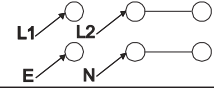
The cooker is manufactured to work with three-phase alternating current (380-415V 3N~50 Hz). The voltage rating of the cooker heating elements is 220-240V. Adapting the cooker to operate with one phase current is possible by appropriate bridging in the connection box according to the connection diagram below. The connection diagram is also found on the cover of the connection box. Remember that the connection wire should match the connection type and the power rating of the cooker.

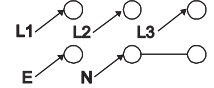
CONNECTION DIAGRAM				Recommended type of connection lead
Caution! Voltage of heating elements 220-240V Caution! In the event of any connection the safety wire must be connected to the  E terminal.				
1	For 220-240V earthed one-phase connection, bridges connect 1-2-3 terminals and 4-5 terminals, safety wire to  .			H05VV-F3G4
2	For 380-415/220-240V earthed two-phase connection, bridges connect 2-3 terminals and 4-5 terminals, the safety wire to  .			H05VV-F4G2,5
3	For 380-415/220-240V earthed three-phase connection, bridges connect 4-5 terminals, phases in succession 1, 2 and 3, earth to  .			H05VV-F5G1,5
L1=R, L2=s, L3=T, N=earth terminal, E=safety wire terminal				

The connection cable must be secured in a strain-relief clamp. For the connection leads, the grounding wire must be longer than the other wires.

### Caution!

Remember to connect the safety circuit to the connection box terminal marked with . Before connecting the cooker to the power supply it is important to read the information on the data plate and the connection diagram.